

DESCRIZIONE

MODELLO
GEMMA CR
CATEGORIA
LAMPARE

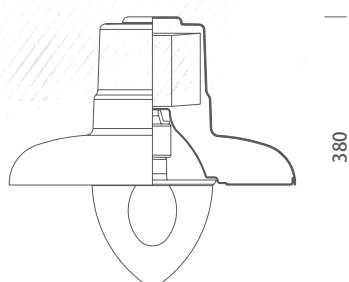

405



MODELLO	potenza max consentita			
GEMMA CR	CABLAGGI INSTALLABILI			
INCANDESCENZA	IODURI-MH	HG. A.P.	NA. A.P.	
200 W	70 W	80 W	70 W	
	100 W	125 W	100 W	
	150 W			

**TIPOLOGIA:**

Apparecchio per illuminazione d'esterni di forma circolare tipo lampara, con diffusore in pirex. Predisposto di portalampada con attacco E27 / E40 per lampade ad incandescenza e fluorescenti compatte a risparmio energetico.

L'apparecchio puo' essere equipaggiato di alimentatore elettro-meccanico, cablato in classe II di isolamento, per l'accensione di lampade a scarica. **A richiesta alimentatore temporizzato bi-potenza 150/100-100/70W.**

VERNICIATURA:

Eseguita su superfici che preventivamente smerigliate, sabbiate ed accuratamente sgrassate, vengono sottoposte ad un trattamento di cromattazione. Verniciatura con polveri poliesteri e successiva polimerizzazione in forno a 185° C.

STRUTTURA:

In alluminio 99% spessore 20/10 o a richiesta in lastra di rame spessore 12/10. Riflettore in alluminio 99% spessore 20/10 verniciato bianco.

CARATTERISTICHE ELETTRICHE:

L'apparecchio è conforme alle norme EN-60598-1, EN 60598-2-3, ed ai requisiti essenziali di sicurezza dell'Unione Europea. **Grado di protezione IP 44** per applique e lampioni, **IP 40** per sospensioni a catena, classe di isolamento CL1 (è necessario il collegamento all'impianto di messa a terra eseguito a norma).



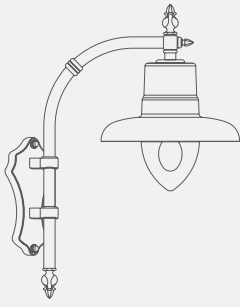

modello: GEMMA CR
articolo: **90B**
misure mm: L640 x H855

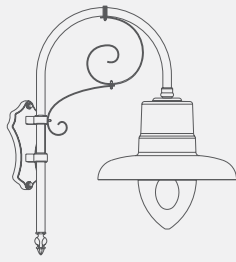

modello: GEMMA CR
articolo: **44B.SR**
misure mm: L640 x H855

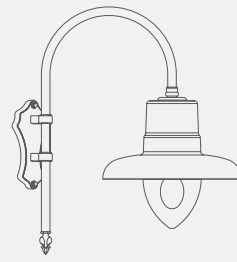

modello: GEMMA CR
articolo: **44B**
misure mm: L640 x H855

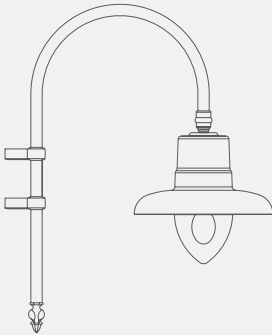

modello: GEMMA CR
articolo: **44C**
misure mm: L770 x H955

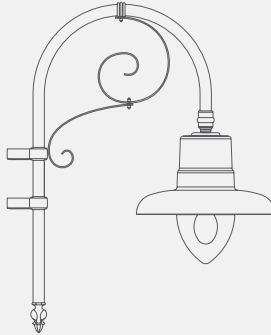

modello: GEMMA CR
articolo: **44C.SR**
misure mm: L770 x H955

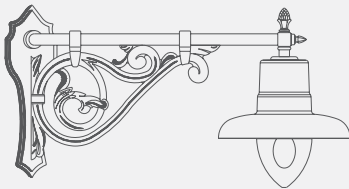

modello: GEMMA CR
articolo: **PE1.B**
misure mm: L1000 x H530

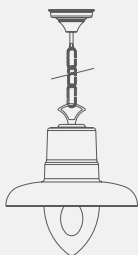

modello: GEMMA CR
articolo: **45**
misure mm: L405 x H915

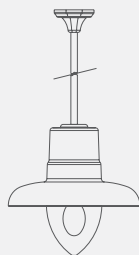

modello: GEMMA CR
articolo: **4F**
misure mm: L405 x H945



art. 90B



art. 44C



art. 72.44

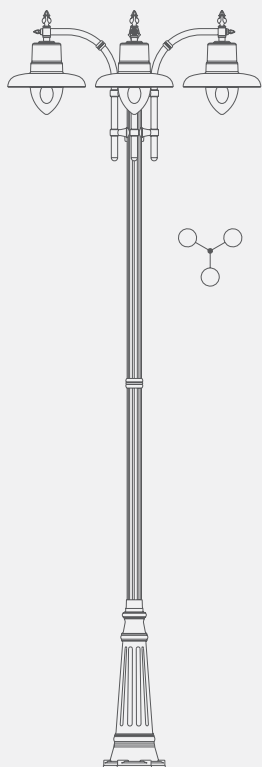
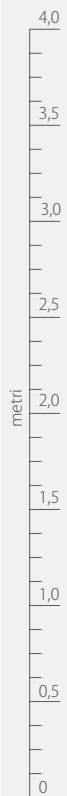

▀ modello: GEMMA CR
articolo: **75.B8/3.90B**
altezza tot. cm 394
palo tipo: 75/B8

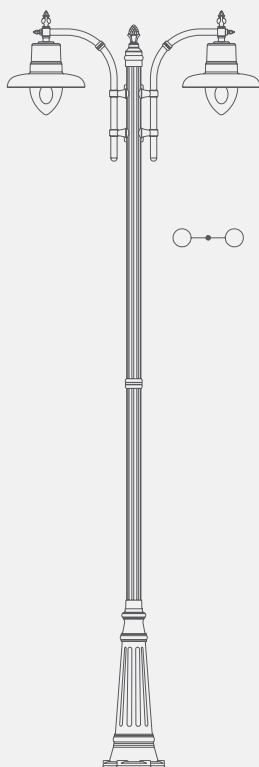

▀ modello: GEMMA CR
articolo: **75.B8/2.90B**
altezza tot. cm 394
palo tipo: 75/B8

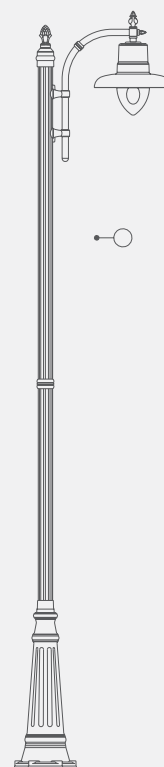

▀ modello: GEMMA CR
articolo: **75.B8/1.90B**
altezza tot. cm 394
palo tipo: 75/B8

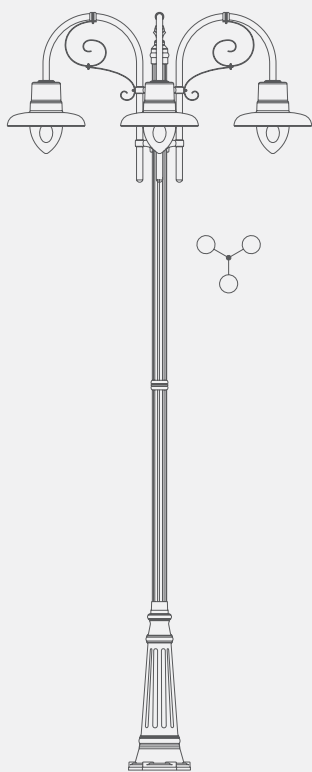
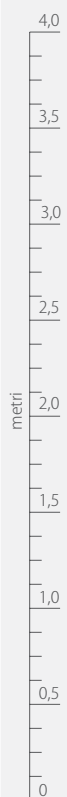

▀ modello: GEMMA CR
articolo: **75.B8/3.445R**
altezza tot. cm 397
palo tipo: 75/B8

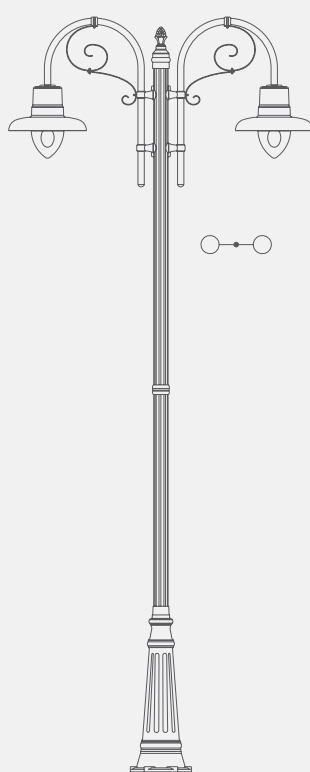

▀ modello: GEMMA CR
articolo: **75.B8/2.445R**
altezza tot. cm 397
palo tipo: 75/B8

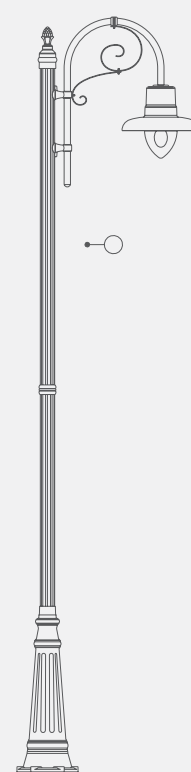

▀ modello: GEMMA CR
articolo: **75.B8/1.445R**
altezza tot. cm 397
palo tipo: 75/B8

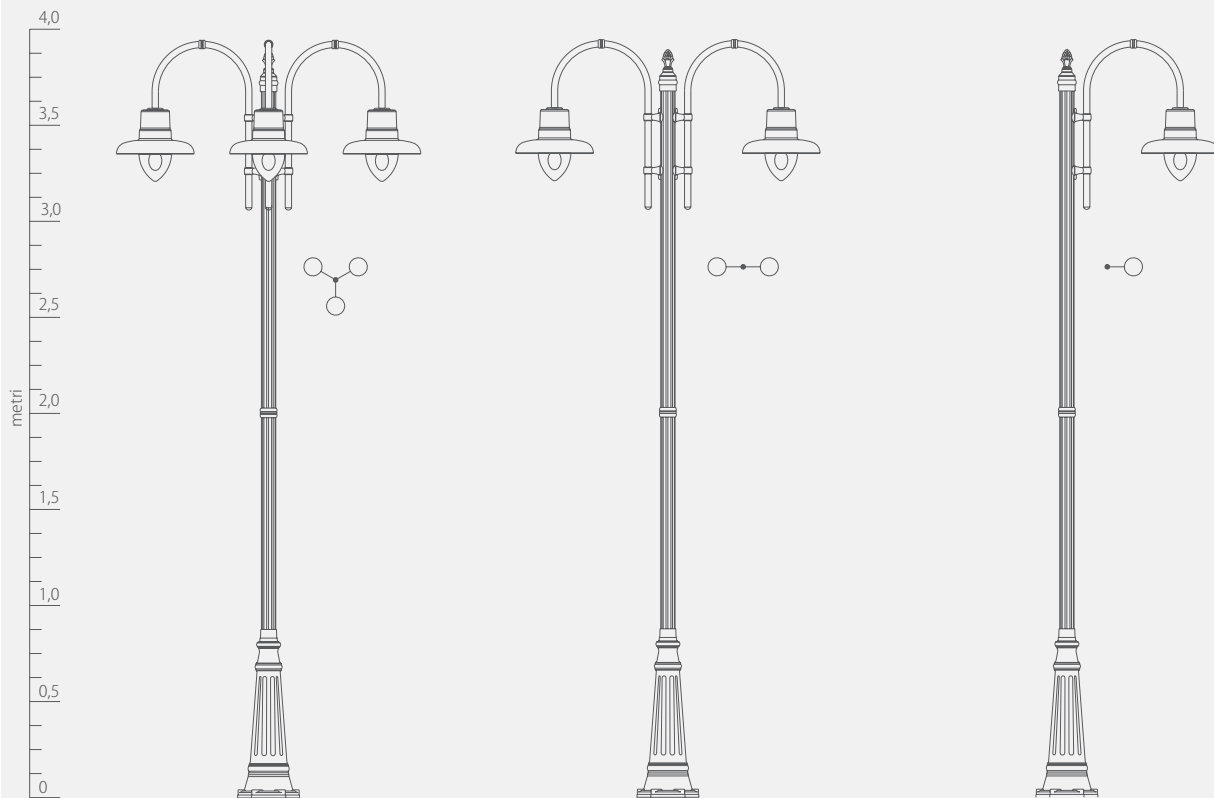

▶ modello: GEMMA CR
 articolo: **75.B8/3.44**
 altezza tot. cm 397
 palo tipo: 75/B8

▶ modello: GEMMA CR
 articolo: **75.B8/2.44**
 altezza tot. cm 397
 palo tipo: 75/B8

▶ modello: GEMMA CR
 articolo: **75.B8/1.44**
 altezza tot. cm 397
 palo tipo: 75/B8



