

DESCRIZIONE

MODELLO
MERAK
CATEGORIA
LAMPARE

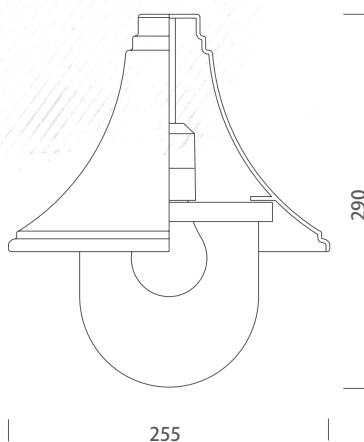

MODELLO	potenza max consentita		
MERAK			
CABLAGGI INSTALLABILI			
INCANDESCENZA	IODURI-MH	HG. A.P.	NA. A.P.
75 W			

**TIPOLOGIA:**

Apparecchio per illuminazione d'esterni di forma classica a campana tipo lampara con diffusore in policarbonato trasparente. Predisposto con portalampada attacco E27 per lampade ad incandescenza e fluorescenti compatte a risparmio energetico.

VERNICIATURA:

Eseguita su superfici che preventivamente smerigliate, sabbiate ed accuratamente sgrassate, vengono sottoposte ad un trattamento di cromattazione. Verniciatura con polveri poliesteri e successiva polimerizzazione in forno a 185° C.

STRUTTURA:

In alluminio 99% spessore 20/10 o a richiesta in lastra di rame spessore 12/10. Riflettore in alluminio 99% brillantato a specchio spessore 12/10.

CARATTERISTICHE ELETTRICHE:

L'apparecchio è conforme alle norme EN-60598-1, EN 60598-2-3, ed ai requisiti essenziali di sicurezza dell'Unione Europea. **Grado di protezione IP 54** per applique e lampioni, **IP 40** per sospensioni a catena, classe di isolamento CL1 (è necessario il collegamento all'impianto di messa a terra eseguito a norma).



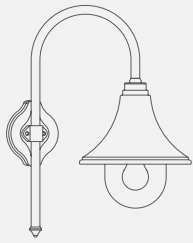

modello: MERAK
 articolo: **2B**
 misure mm: L420 x H530



modello: MERAK
 articolo: **14B**
 misure mm: L410 x H360

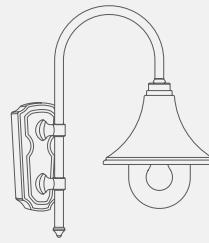

modello: MERAK
 articolo: **1**
 misure mm: L430 x H530

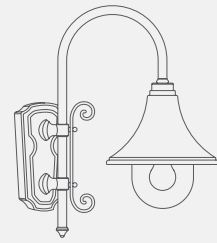

modello: MINELAUVA
 articolo: **1R**
 misure mm: L430 x H530

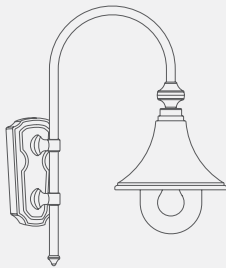

modello: MERAK
 articolo: **1G**
 misure mm: L470 x H590

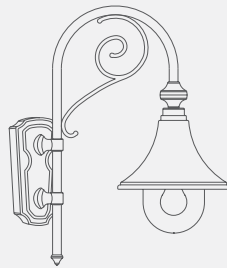

modello: MERAK
 articolo: **1G.SR**
 misure mm: L470 x H590

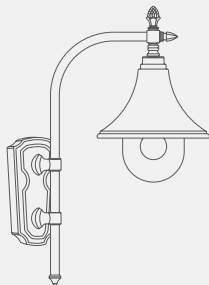

modello: MERAK
 articolo: **90B**
 misure mm: L430 x H640



modello: MERAK
 articolo: **K1B**
 misure mm: L360 x H360



modello: MERAK
 articolo: **4S**
 misure mm: L250 x H780



modello: MERAK
 articolo: **4F**
 misure mm: L250 x H450



modello: MERAK
 articolo: **3A.45** tubo d. 45mm
3A.60 tubo d. 60mm
 misure mm: L420 x H530



▀ modello: MERAK
 articolo: **60/3**
 altezza tot. cm 230
 palo tipo: 60

▀ modello: MERAK
 articolo: **60/2**
 altezza tot. cm 230
 palo tipo: 60

▀ modello: MERAK
 articolo: **60/1**
 altezza tot. cm 230
 palo tipo: 60

▀ modello: MERAK
 articolo: **45/1**
 altezza tot. cm 195
 palo tipo: 45



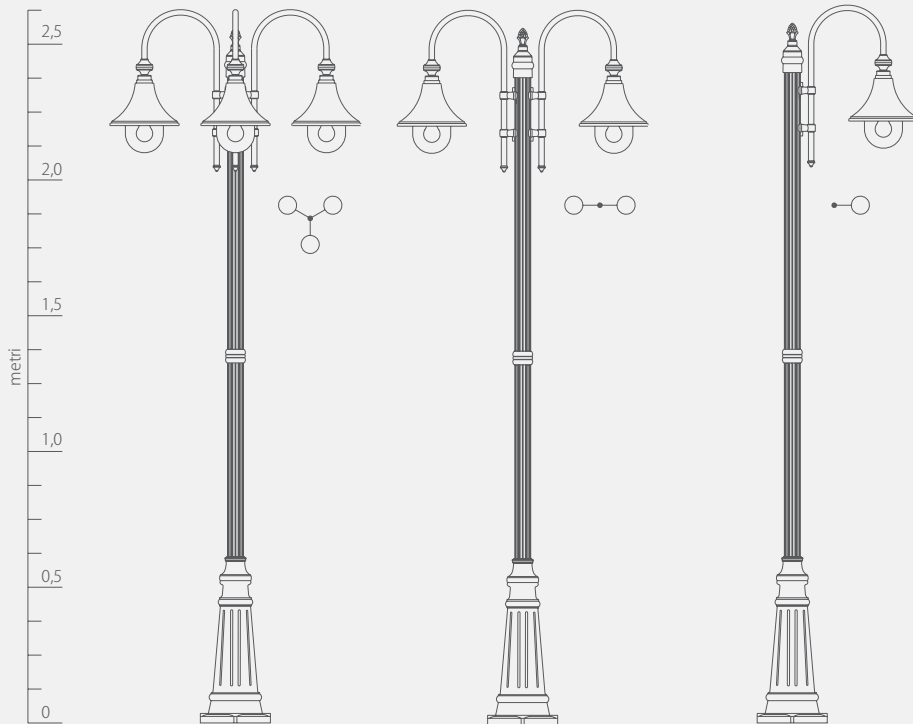

▀ modello: MERAK
 articolo: **60.B5/3G**
 altezza tot. cm 263
 palo tipo: 60/B5

▀ modello: MERAK
 articolo: **60.B5/2G**
 altezza tot. cm 263
 palo tipo: 60/B5

▀ modello: MERAK
 articolo: **60.B5/1G**
 altezza tot. cm 263
 palo tipo: 60/B5

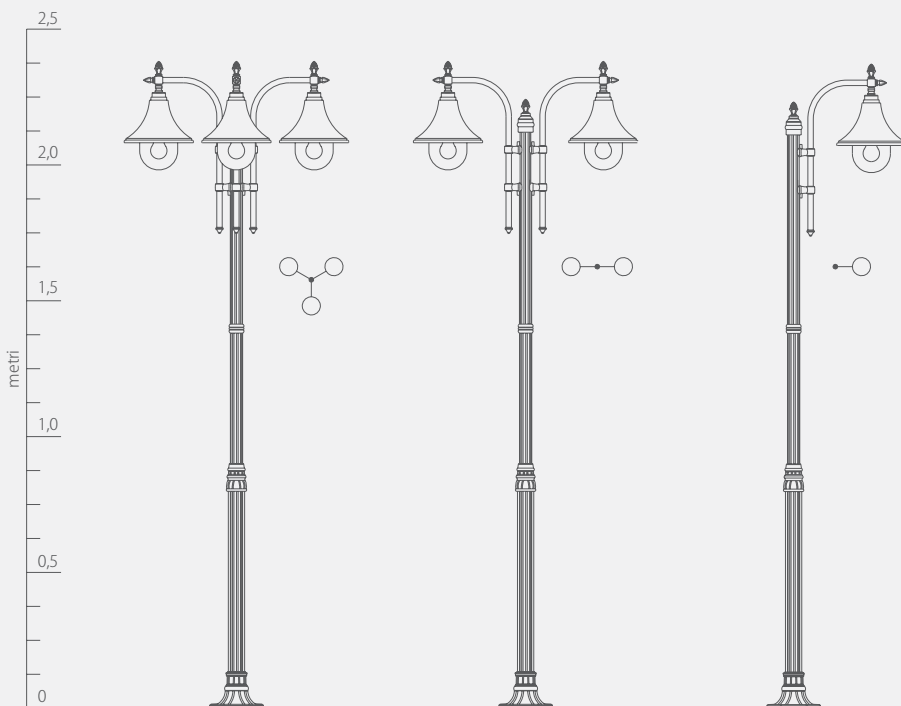

▀ modello: MERAK
 articolo: **60.45/90.3**
 altezza tot. cm 238
 palo tipo: 60.45

▀ modello: MERAK
 articolo: **60.45/90.2**
 altezza tot. cm 238
 palo tipo: 60.45

▀ modello: MERAK
 articolo: **60.45/90.1**
 altezza tot. cm 238
 palo tipo: 60.45



art. 90.B



art. 45C/1



art. _/2

